

USER MANUAL

Cervitrac™

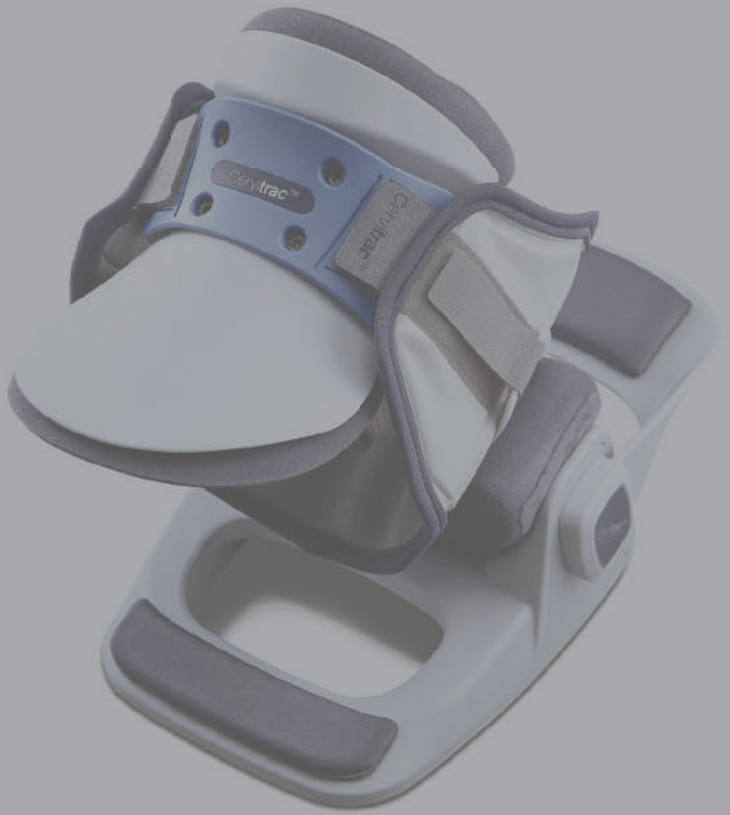

DDS CERVICAL TRACTION COLLAR



**Thank you for choosing DDS
and welcome to an enjoyable life
free from neck pain.**

Table of Contents

- 4 What's inside the box
- 5 What it is & how it works
- 6 Features of the DDS Cervitrac™
- 7 How to use the product
- 9 Contraindications & Precautions
- 10 Maintenance
- 11 Registration & Warranty Card

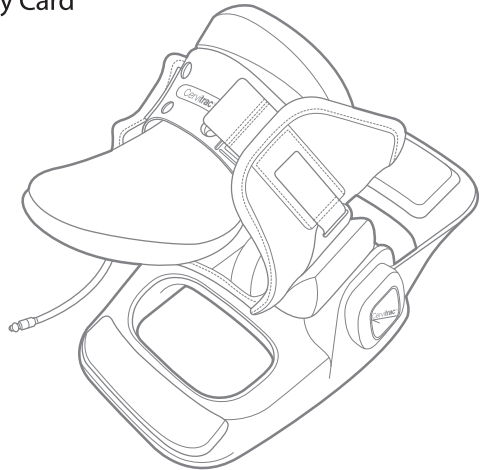

What's Inside the Box

Cervitrac™

CHIN COLLAR

(Front)

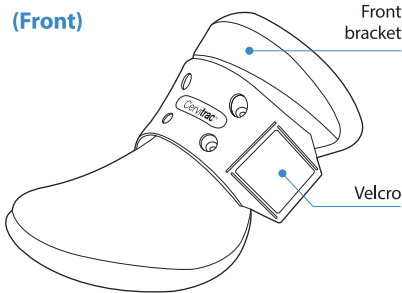

(Back)

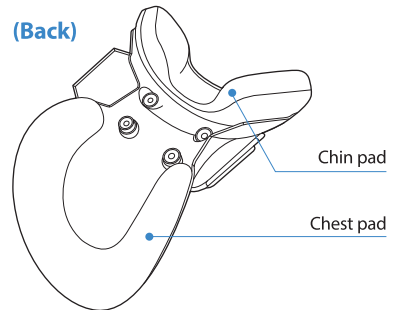

TRACTION BELT

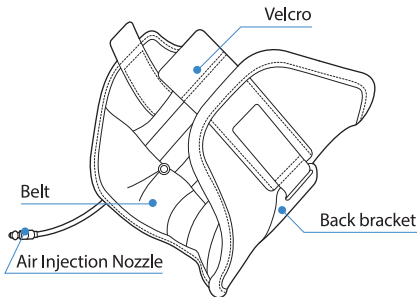

STAND

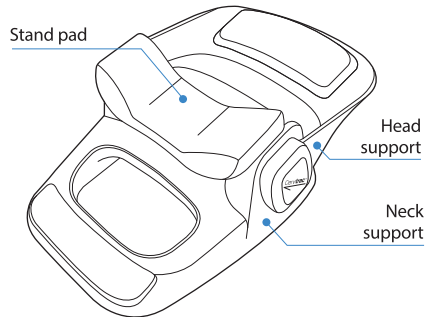

HAND PUMP

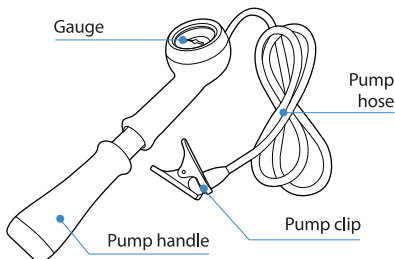

Manual

What it is & how it works

The **DDS Cervitrac** is the most comprehensive Cervical Traction Device for treating neck pain. It's the first device that offers the option to receive pneumatic traction while lying down in the supine position or upright for mobile treatment. The soft traction collar can detach from the Cervitrac frame giving you total freedom to treat your condition however you wish. It's lightweight, easy to use and will reduce disc pressure within the cervical spine effectively eliminating pain.

Before Treatment

The herniated or bulging cervical disc, or herniated nucleus pulposus, applies pressure on the nerve root, ultimately causing pain.

After Treatment

The DDS Cervitrac alleviates pain and assists active-rehabilitation by allowing the cervical disc, or nucleus pulposus, to return to its natural position. By increasing the intervertebral space, pressure applied on the nerve root is relieved, naturally reducing pain.

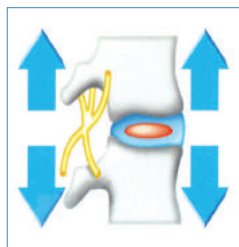

Features of the DDS Cervitrac

1. The DDS Cervitrac can assist with the following indications:
 - Whiplash injuries (injuries which do not involve breakage or dislocation of the bones)
 - Job-related neck pain, i.e., prolonged computer use, sewing, etc.
 - Sports injuries (without breakage or dislocation)
 - Joint changes
 - Degenerative changes (arthritis)
 - Joint pain/symptomatic facet Joint
 - Muscle spasm and guarding
 - Postcompression fracture
 - Nerve impingement (subacute-chronic phase)
 - Herniated disc
 - Narrowing foramen
 - Spondylolisthesis
 - Spondylolysis
 - Compressions or radiculopathies
2. Treats bulging and/or herniated discs eliminating neck pain. Bulging and herniated discs are reduced by elongating the intervertebral spaces in the cervical spine.
3. Relaxes muscle spasms, muscle cramps, strain and pain.
4. Helps treat degenerative disc disease, spinal stenosis, sciatica and spondylolysis.
5. Helps maintain proper posture.
6. Assists individuals with strenuous jobs.
7. Is very lightweight and comfortable.
8. Is made of highly durable material.
9. Simple to use.

How to use the product

Supine Position

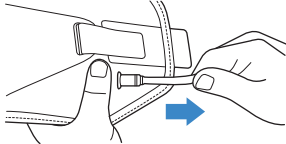
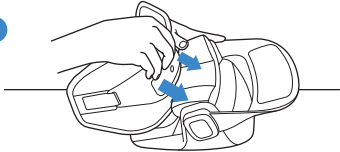
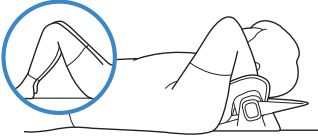
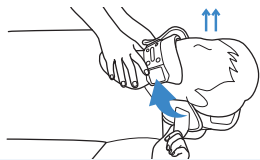
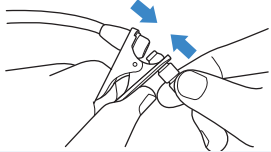
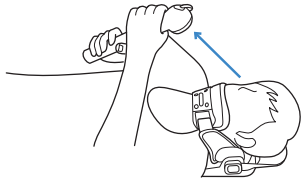
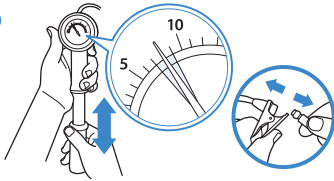
<p>1</p>  <p>Place the Stand on a level floor surface.</p>	<p>2</p>  <p>Gently pull the Air Injection Hose to release any remaining air from the Traction Belt. The Belt must be completely deflated before application.</p>
<p>3</p>  <p>Attach the Traction Belt to the center of the Stand via Velcro.</p>	<p>4</p>  <p>Lie down and carefully place your neck on the center of the Traction Belt with your legs bent at a 45° angle.</p>
<p>5</p>  <p>While looking straight up, place the Chin Collar on your chin and fasten it to the Traction Belt via the Velcro attachments.</p>	<p>6</p>  <p>Connect the Hand Air Pump to the Air Valve precisely attaching the Air Injection Tong with the Air Valve.</p>
<p>7</p>  <p>Proceed to slowly use the Hand Air Pump to inflate the Belt. Inflate at a rate that is no faster than 1 stroke in each direction every 5 seconds. Start with a low pressure (5 PSI) on the first day and gradually increase to 7 PSI on the second day and then to 9 PSI on the third day. Recommend usage is 7-9 PSI or less depending on your comfort.</p>	<p>8</p>  <p>Wear for 15-30 minutes. You can adjust the air pressure at anytime to your comfort level by momentarily pressing the Air Valve to release air. Release pressure to reach a comfortable PSI level if experiencing any discomfort.</p>

IMPORTANT: You MUST release the air completely out of the device before removal. You can do so by pulling the air injection hose as shown above in Step 2.

WARNING: Do not attempt to sit up, stand or move your head left or right when using the Cervitrac from the supine position. You must remain in the supine position until the Cervitrac is completely removed.

Sitting or Standing Position

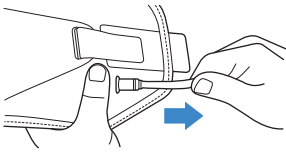
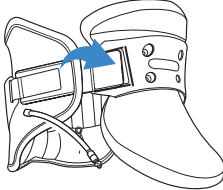
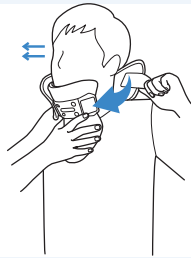
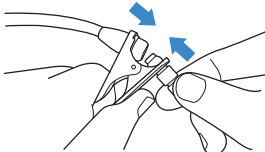
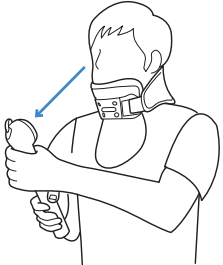
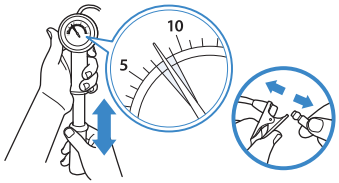
<p>1</p> 	<p>2</p> 
<p>Gently pull the Air Injection Hose to release any remaining air from the Traction Belt. The Belt must be completely deflated before application.</p>	<p>Connect the Traction Collar to the Fixed Chin Collar on one side to prepare positioning on your neck.</p>
<p>3</p> 	<p>4</p> 
<p>Position the Fixed Chin Collar so that the chin fits comfortably in the chin groove. Make sure the device is attached evenly and is centered around your neck.</p>	<p>Connect Hand Air Pump to the Air Valve precisely attaching the Air Injection Tongs with the Air Valve.</p>
<p>5</p> 	<p>6</p> 
<p>Proceed to slowly use the Hand Air Pump to inflate the belt. Inflate the bladder at a rate that is no faster than 1 stroke in each direction every 5 seconds. Start with a low pressure (5 PSI) on the first day and gradually increase to 7 PSI on the second day and then to 9 PSI on the third day. Recommended usage is 7-9 PSI or less depending on your comfort.</p>	<p>Wear for 15-30 minutes. You can adjust the air pressure at anytime to your comfort level by momentarily pressing the Air Valve to release air. Release pressure to reach a comfortable PSI level if experiencing any discomfort.</p>

IMPORTANT: You MUST release the air completely out of the device before removal. You can do so by pulling the air injection hose as shown above in Step 1.

WARNING: Do not attempt to lie down or move your head left or right while wearing the Brace.

Contraindications

Patients with any of the following health conditions should notify their physicians before administering DDS:

- high blood pressure
- cardiovascular diseases: uncontrolled hypertension, aortic aneurysm, congestive heart failure
- severe cervical spine instability
- severe osteoporosis
- cerebrovascular diseases
- post spine operation prior to the third month
- cervical tumor
- TMJ concerns

Precautions

- 1 The DDS Cervitrac should be used under the supervision of a licensed health care provider.
- 2 Inflate with extreme caution. Do not inflate at a rate faster than one pump in each direction every 5 seconds.
- 3 Start at a slow pace-inflate to only 5 PSI on the first day, 7 PSI on the second day, 9 PSI on the third day. Immediately release air to reach a comfortable PSI level if experiencing any discomfort.
- 4 Recommended usage is 9 PSI or less depending on your comfort.
- 5 Extra caution and care must be taken with patients with TMJ concerns.
- 6 Do not lie down with the device inflated unless starting application from supine position with the Cervitrac Stand.
- 7 Do not turn your neck either left or right while wearing the device.
- 8 Consult a physician if the pain increases.
- 9 Handle with care; dropping the Hand Air Pump can result in malfunction.
- 10 Shut the Air Valve tightly before washing. Water must not enter the device. For more information regarding washing proceed to page 10.

Warning: Failure to follow contraindications and precautions may lead to serious injury and damage to the product.

Cleaning, storage, and maintenance

How to clean the product

- Before cleaning, separate the traction belt, the neck support, and the sponge pad from the stand.
- **Neck support and stand:** Clean with a damp cloth, and let it dry in a shaded area.
- **Traction belt:** Inject air with a pressure of 5 psi or so into the product, and turn the air inlet in a clockwise direction to close it so as to avoid water from entering the product. Use a smooth sponge and gently scrub the product while soaked in water mixed with neutral detergent. After cleaning, use a dry cloth to blot away excess moisture and let it dry in a shaded area.
- **Sponge pad:** Scrub the product gently while soaked in water mixed with neutral detergent. After cleaning, use a dry cloth to blot away excess moisture, and let it dry in a shaded area.
- Do not wring out or use the spin cycle of a washing machine.
- Do not use any chemical product other than neutral detergent when cleaning the product.
- Do not apply heat from a dryer when drying the product after cleaning.

Storage and maintenance

- Release air when the product is not in use.
- Keep the product out of reach of children.
- Keep the belt away from sharp objects or high-temperature and flammable materials, including heaters.
- Store the product in a place where temperature/humidity levels are not high, and avoid exposure to direct sunlight.

Registration / Warranty Card

FIRST NAME: _____ MI: _____ LAST: _____

ADDRESS 1: _____

ADDRESS 2: _____

CITY: _____ STATE: _____ ZIP: _____

PHONE (DAY): _____ (EVENING) _____

PRODUCT INFORMATION

DATE OF PURCHASE: _____

DDS MODEL:

DDS Cervitrac™

HOW DID YOU BECOME AWARE OF DDS?

MAIL TO SERVICE CENTER: DDS, INC.
100 Commerce Way, Suite 5
Hackensack, NJ 07601 U.S.A.

Limited 3 Year Warranty

DDS, Inc. will repair or replace the unit free of charge for a 3 year period from the date of purchase. The warranty is covered only if the device is defective in workmanship or materials.

To obtain service under this warranty, please mail the warranty card at the time of purchase. You may then return the defective product to the service center on the warranty card, together with your purchase receipt and \$5.00 postage and handling. In the absence of a purchase receipt, an invoice must to be produced from the seller. This warranty does not apply for any misuse and/or deliberate mishandling of our products.

Any implied warranty, obligations or liabilities, including but not limited to the implied warranty of merchantability fitness for a particular purpose, shall be limited in duration to the 3 year duration of this written, limited warranty.

Some states do not allow limitations on how long an implied warranty lasts, so the limitations may not apply to you.

In no event shall DDS be liable for any special, incidental or consequential damages for breach of any other warranty, express or implied whatsoever.

Some states do not allow the exclusion and the limitation may not apply to you.

This warranty gives you specific legal rights. These rights may vary according to your state laws.

Cervitrac™

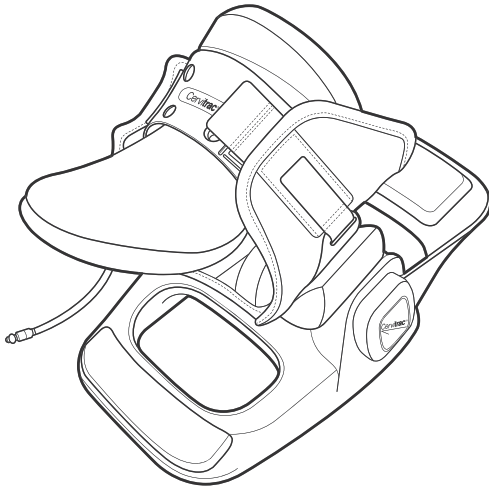

Disc Disease Solutions, Inc.

100 Commerce Way, Suite 5
Hackensack, NJ 07601
U.S.A.

Tel: (888) 495-7440
Fax: (201) 880-7799
info@discdiseasesolutions.com

For Canada please contact

Tel: (204) 470-5741
canada@discdiseasesolutions.com

www.DDSbelt.com